

EXTRA FLAT™









43" / 50"

Operating Manual



Well thought-out space-saving!

Outperform. Outlast.™

	C.01	INTRODUCTION		
	C.02	FEATURES		
	C.03	PRODUCT DIMENSIONS		
	C.04	INITIAL PRODUCT SET UP		
			Set-up	P.06
			Images	P.07
	C.05	PRODUCT CONTROL		
	C.06	PRODUCT INTEGRATION		
	C.07	RECOMMENDED INSTALLION		
			Example of console integration	P.12
			Example of back of sofa integration	P.13
	C.08	TROUBLE SHOOTING		
	C.09	LEGAL NOTICE		

Outperform. Outlast.™

Intended Use

The product serves the lifting and lowering of LCD and plasma TV equipment. All company names and product names are trademarks of the corresponding owner. All rights reserved. The scope of supply can vary depending on the product and the range of fixtures and fittings. Please check that the product supplied is complete and inform us within seven days of delivery if the scope of supply is not complete.

Safety and Hazards Recommendations

Please read this chapter carefully and follow all of the instructions provided. In this way you are able to guarantee the reliable operation and a long lifespan for your lift system. Keep the operating manual in a safe place.

In the event of damage which is the result of non compliance with this operating manual, all claims pertaining to the guarantee are null and void. We generally accept no responsibility for secondary damage. We accept no responsibility for damage to objects or persons which is caused by the inappropriate use of the product or through ignoring the safety instructions. In such cases, all claims pertaining to the guarantee are null and void.

- ⇒ For safety reasons, the unauthorized conversion and/or changing of the product is not permitted. Do not dismantle this product.
- ⇒ This product is not a toy and does not belong in the hands of children.
- ⇒ Do not allow the product to become damp or wet.
- ⇒ Do not leave the packaging material lying around as children may choke if they swallow it.
- ⇒ The product will be damaged if it is dropped, even from a low height.
- ⇒ Before using the product for the first time, please check that the free raising and lowering of the Flatlift including the mounted TV equipment is possible and ensure a collision-free run.

For legal reasons and insurance purposes, your Flatlift is equipped with an 'automatic safety device'.

This means that the button which controls the raising and lowering must be pressed down all the time.

The system stops and remains in the same position as soon as you let go of the button.

Quality

In the choice of our components, our primary focus was on ensuring a high level of functionality, straightforward use, safety and reliability.

We would like to thank you for the trust you have placed in our Flatlift brand products.

We can help you with your installation through providing individual customer care.



Outperform. Outlast.™

Features:

- ⇒ Installation base
W=15.75 in D=8.46 in
- ⇒ Installation dimensions, Flatlift
W=30.91 in D=3.34 in H=31.49 in
- ⇒ Lift 37.99 in
- ⇒ Lifting speed 1.77 in/sec
- ⇒ TV weight max. 99.2 lbs / including cover (P.011)
- ⇒ TV size 43-50" (inches)
(max. TV size possible in mm: W = * , H = max. 36.07 in, D = *)
- ⇒ Power-on time 18%/h
- ⇒ Can be tilted (-15° manual).
- ⇒ Soft Start / Soft Stop
- ⇒ Low noise level < 45 dB
- ⇒ Environmental temperature from +5°C to 40°C
- ⇒ Connection to room control system possible (refer to P.09 image 5)
- ⇒ Automatic TV switch-off (optional)
- ⇒ Inch-exact programming of the stopping point (optional)
- ⇒ 110V emergency power supply (optional)

Scope of supply:

- ⇒ Flatlift Pop-Up
- ⇒ Control box
- ⇒ 110V power cord
- ⇒ Motor cable
- ⇒ 12V wall power supply for the receiver
- ⇒ Radio remote control

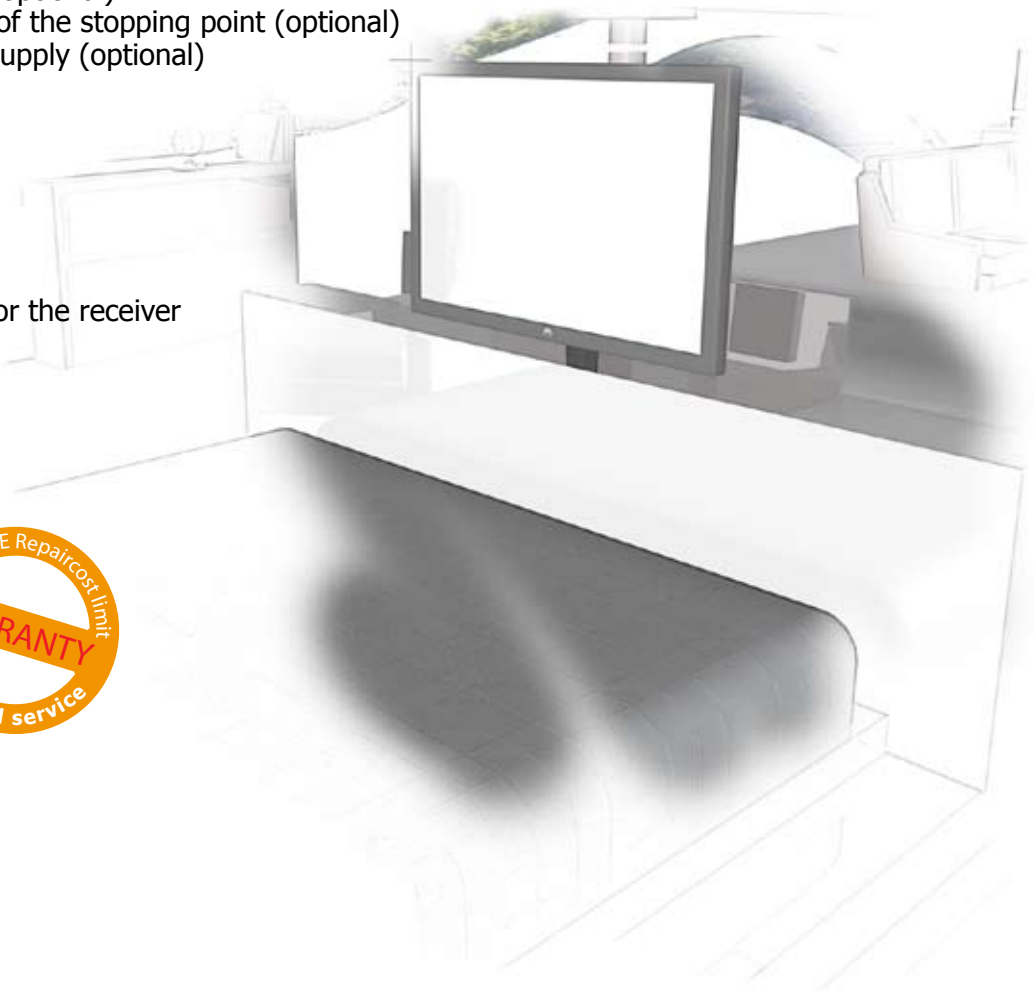

Outperform. Outlast.™

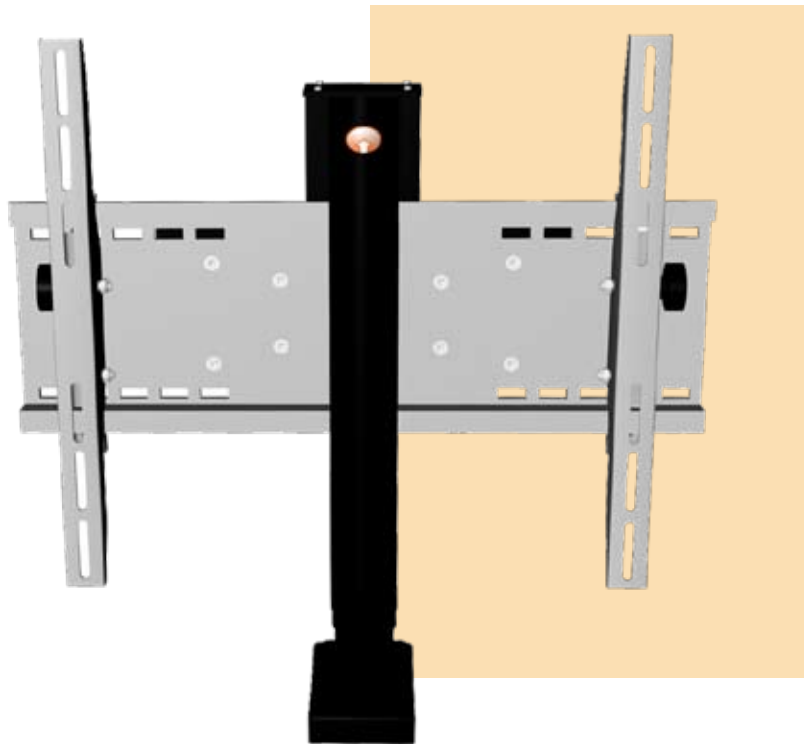
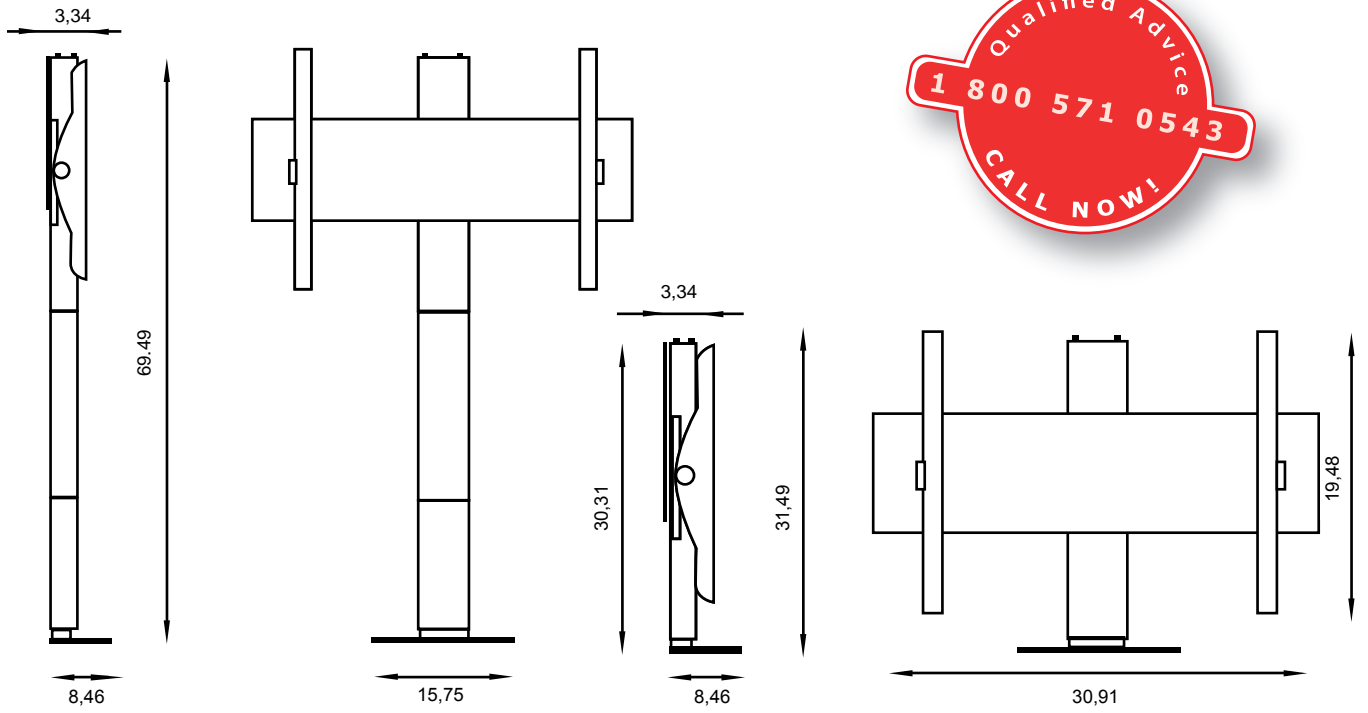

Outperform. Outlast.™

Initial set up:

1. In order to prevent the system from tipping over, fix your Pop-Up installation base to the floor using 4 screws (image 1 no. 1).
2. Connect the Flatlift (image 1, no. 3) with the motor cables (P.07, image 3) and connect these with the control box (image 2, no. 5) at connection point '1'. The motor cables must be connected starting at port 1 and going up.
3. Connect the RJ-45 Western plug of the touchpanel (P.07, image 6, no. 7) to the control box (image 2, no. 6).
4. Connect the control box (image 2, no. 4) with the power cord (P.07, image 4) to the mains supply.
5. Connect the IR eye (P.07, image 5) with the touchpanel. Be sure, that the IR eye (p.07, image 5 no. 9) is not hidden. Place the IR receiver well visibly, because it is very important for the connection between your IR remote control and IR eye.
6. You are now able to mount your TV set on the system. To do this, uncouple the two holders (image 1 no. 2). Attach these to your TV and then secure the holder subsequent to putting the TV set in place by screwing in the safety screw (image 1, no. 4).
7. And that's it. Now you can use your IR remote control comfortable with the buttons „up” and „down” (P.07, image 10, no. 10 and no. 11) to control your Flatlift system.

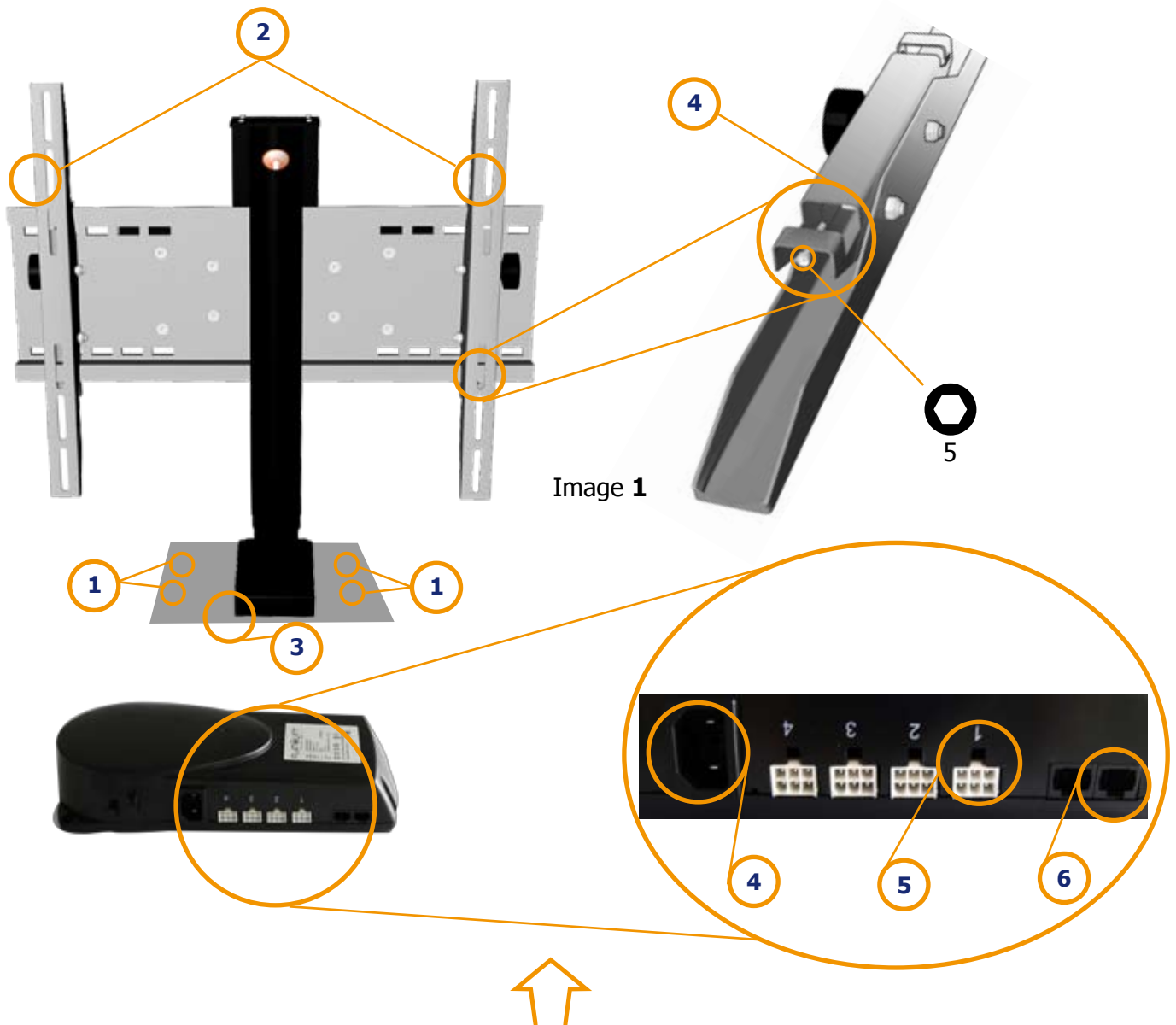

Outperform. Outlast.™



Image 3



Image 4

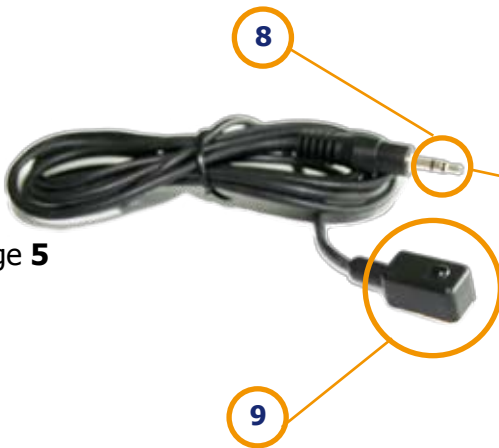

image 5



Image 6

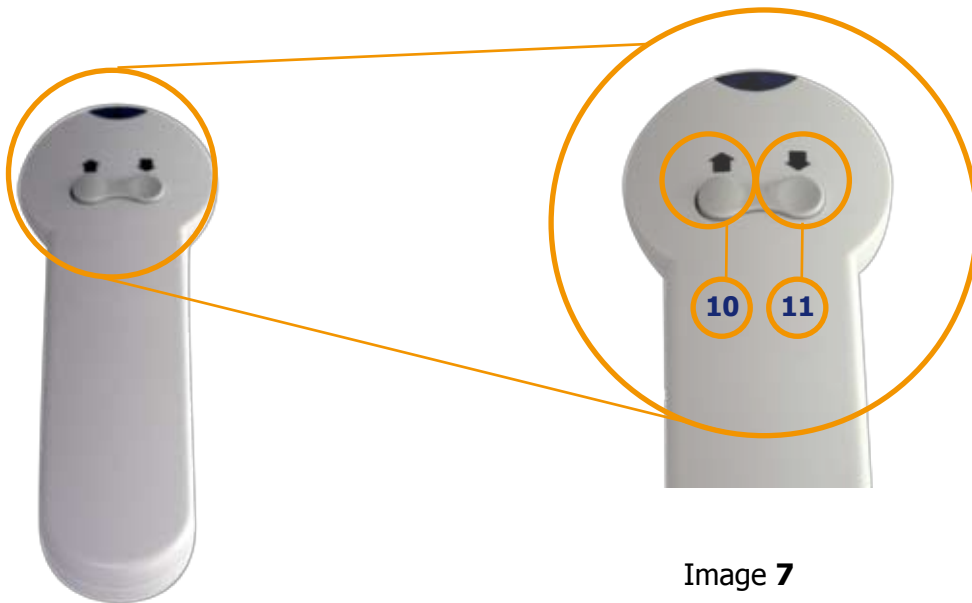

Image 7





Image 1

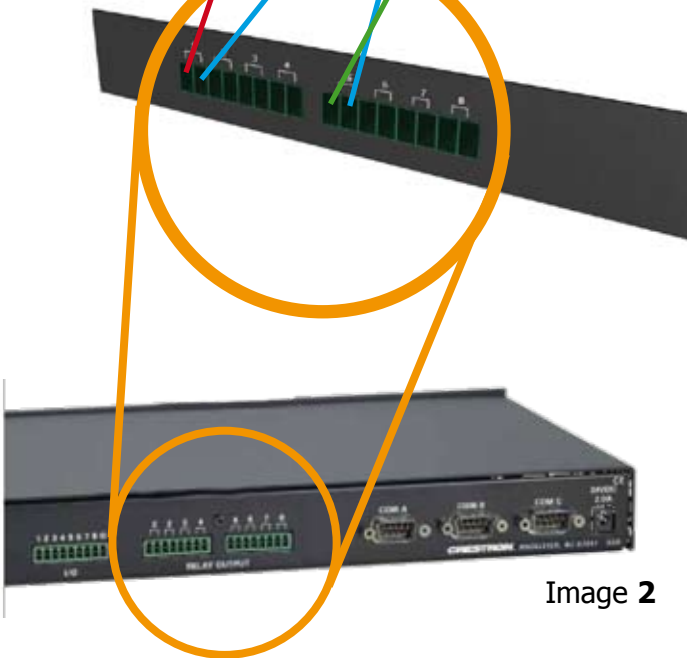

Image 2

Connection to a room control system:

You can connect your Flatlift to a room control system (image 6) if this system has 2 relay outputs with potential free contacts. These relays must be actuated for a programmable time period.

- 1) Use the cables (red, blue and green) from the image 1.
- 2) Now connect the blue and red cable to one of the relay outputs (control command: lower Flatlift).
- 3) Bridge the blue cable onto the second relay output and also attach the green cable to this relay output (lift Flatlift).



Lid variation 1:

A lid closing mechanism on the rear section of the unit incorporating spring damped hinges which opens automatically when the Flatlift moves upwards. Different lid closing solutions are available depending on the realisation of the project (image 1).

The A/V installer which is installing the Flatlift thus enjoys flexibility and can also change the lid solution again at a later time. When the Flatlift retracts, the cover closes softly thanks to the spring dampened hinges.

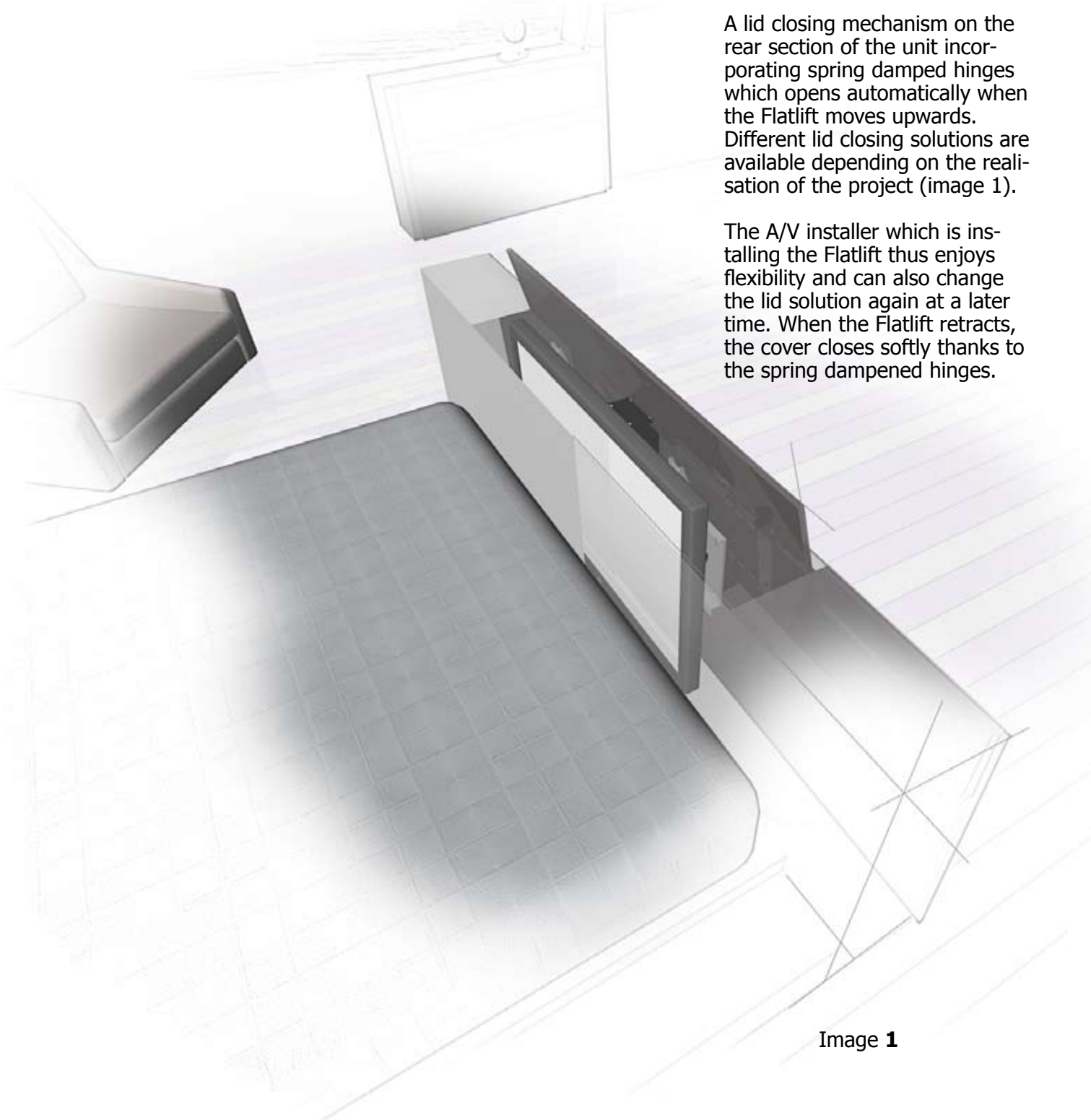

Image 1



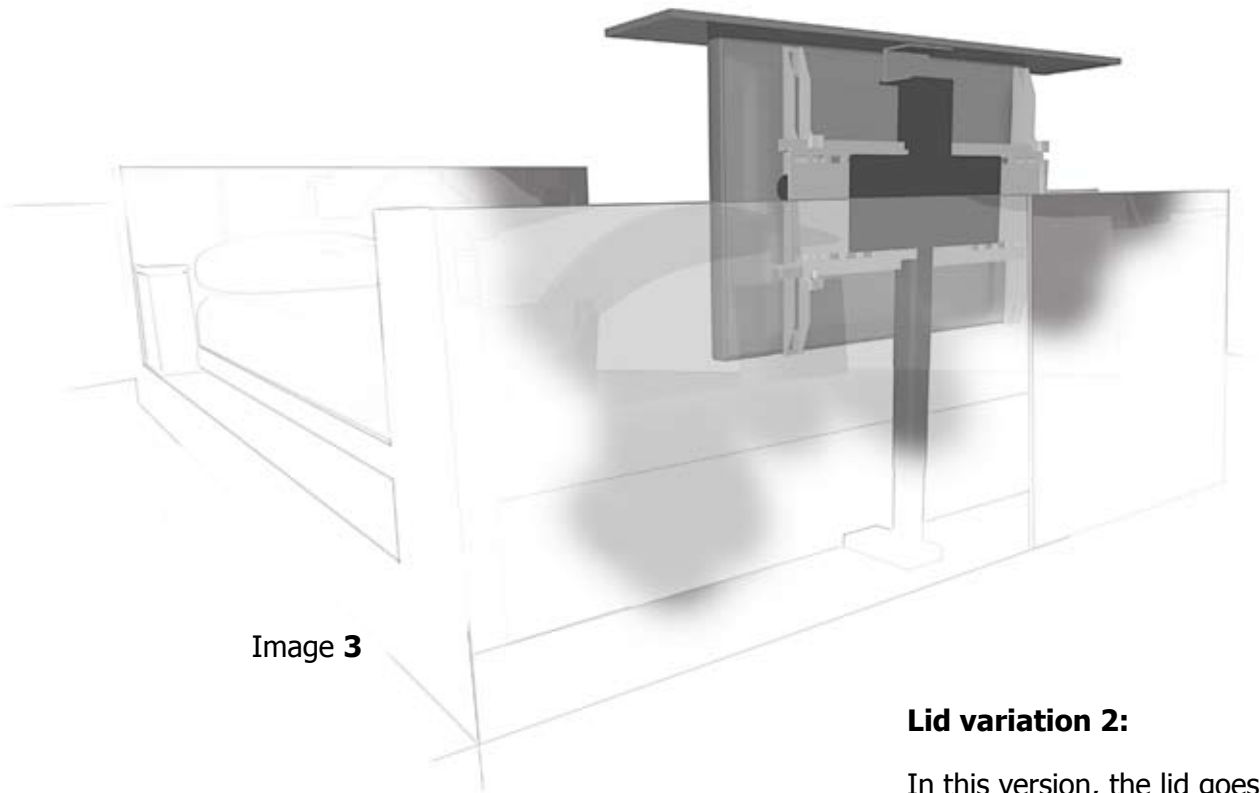

Image 3

Lid variation 2:

In this version, the lid goes up with the Flatlift and rests on the top of the TV set. This variation is known as the 'floating top' version.

Depending on the customer requirements, you can also attach the lid to the Flatlift using a U-bracket (image 3) and/or attach it to the TV holder with 2 L-rods, as shown in image 4.

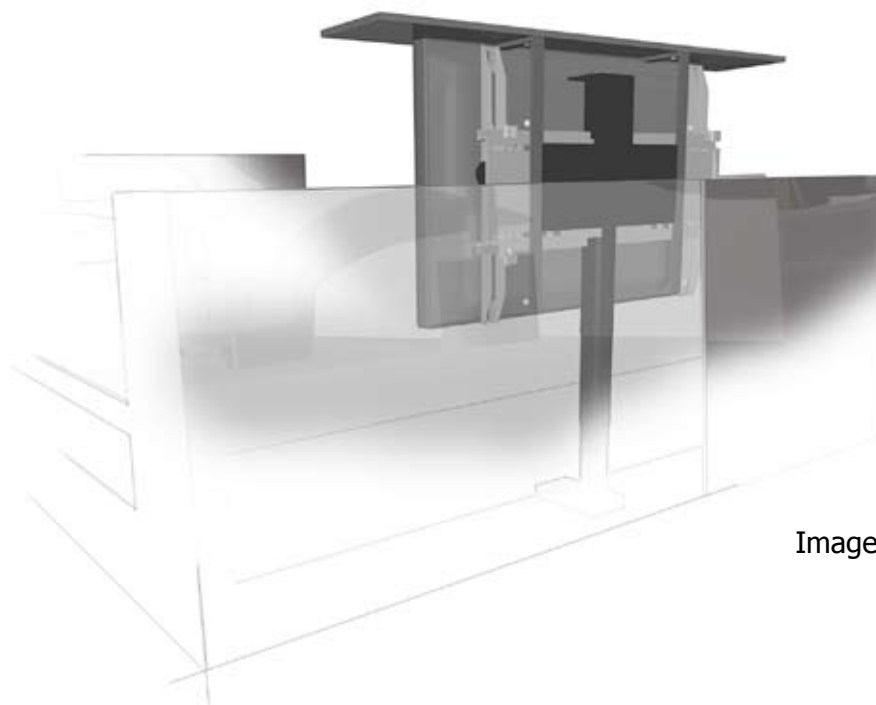

Image 4



Outperform. Outlast.™

Lid variation 3:

With this solution a complete enclosing of the TV is achieved, which blocks out the back of the TV set. This variant is often used in divided rooms and/or on yachts.

WARNING!

With the complete covering of the TV set, the weight of the TV and the weight of the covering must not be too much for the lifting power of Flatlift.

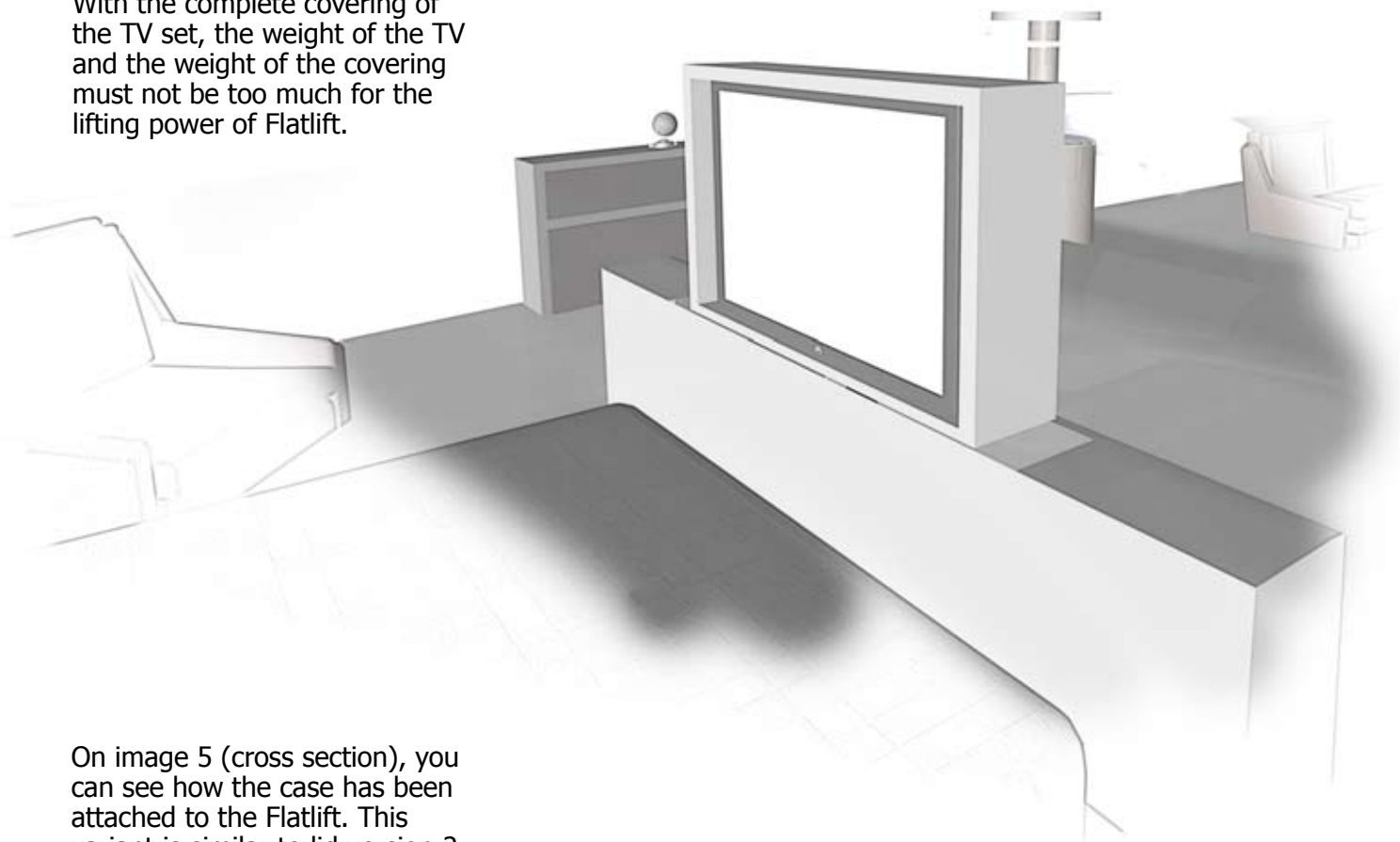

On image 5 (cross section), you can see how the case has been attached to the Flatlift. This variant is similar to lid version 2 (refer to P.10, image 3). When the Flatlift is fully retracted, the lid is flush with the rest of the top of the unit.

Image 5



Outperform. Outlast.™

Recommended installation for integration with furniture:

The 43"/50" Extraflat has a lift height of 37.99" in. As different installation options are possible for the system, we will now explain how the system is to be best arranged with installation on a cabinet.

The following rule applies with cabinet and/or furniture installation:

There must be at least 0.39" in clearance underneath the TV which is attached to the Flatlift. This clearance is always required for the initialisation run. Clearance of at least 0.39" in must also be provided above the TV. When the Flatlift is fully extended, we also recommend a minimum clearance of 0.39" in between the bottom edge of the TV set and the top surface of the furniture.

The following calculation formula therefore results with concern to the height of the TV set:

$$\text{Lift height, Flatlift} = 37.99\text{ in} - 3 \times 0.39\text{ in min. clearance} - (0.47\text{ to } 0.75\text{ in}) \text{ thickness of the cover,} = 36.07\text{ in}$$

36.07" in = max. height of TV

If your TV is bigger or heavier, we recommend you to contact us.

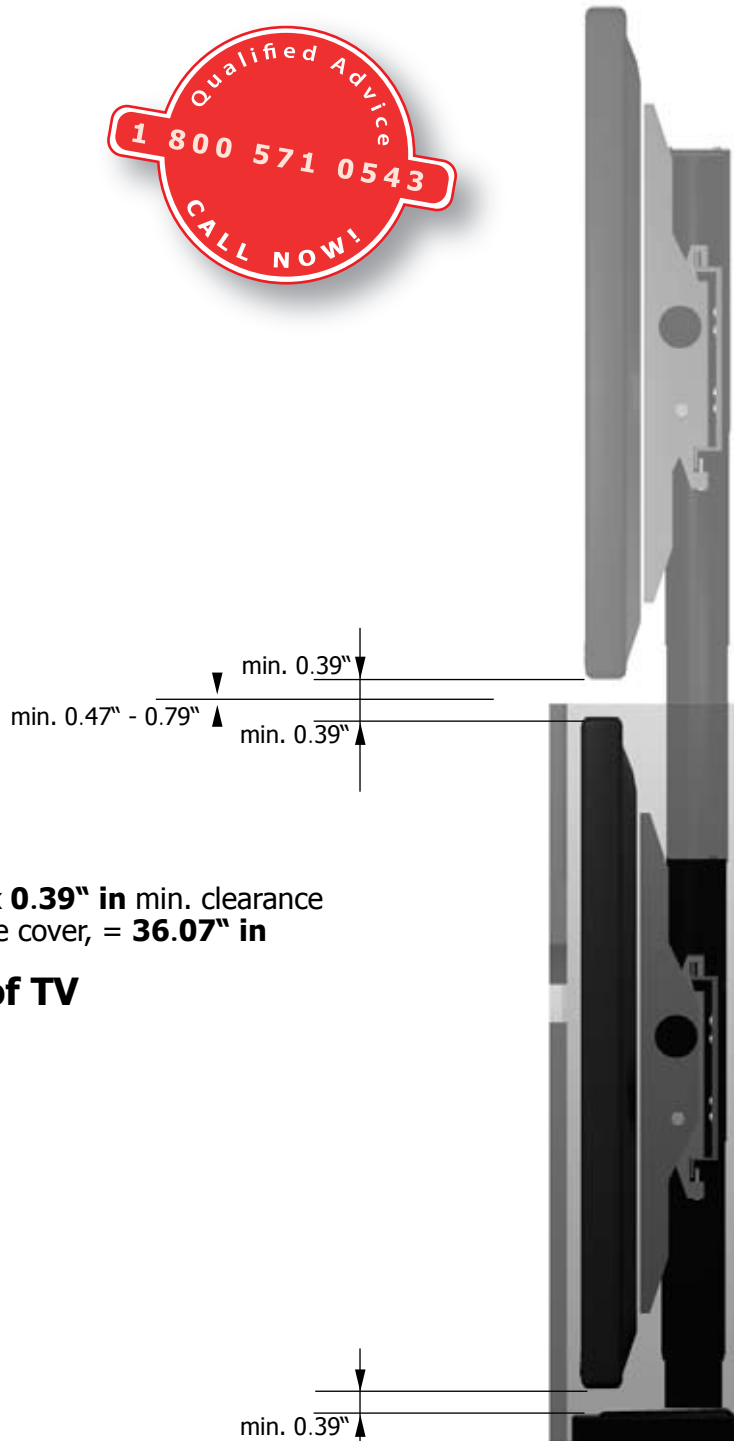

Set up at sofa or couch:

For installation behind a couch or sofa, the following calculation formula results:

Example:

Height of sofa = lift height of 37.99" in - 0.39" in min. clearance from floor - 0.59" in projection = 37.1" in

37.1" in = max. height of TV

With this TV set, the sofa must not be higher than 37.1" in. The same thing applies to the TV. If the TV height is less than 37.1 in, then you can also place the Flatlift on a platform which is the same height as the resulting height difference to the upper edge of the sofa (image 1).

If your TV is bigger or heavier, we recommend you to contact us.

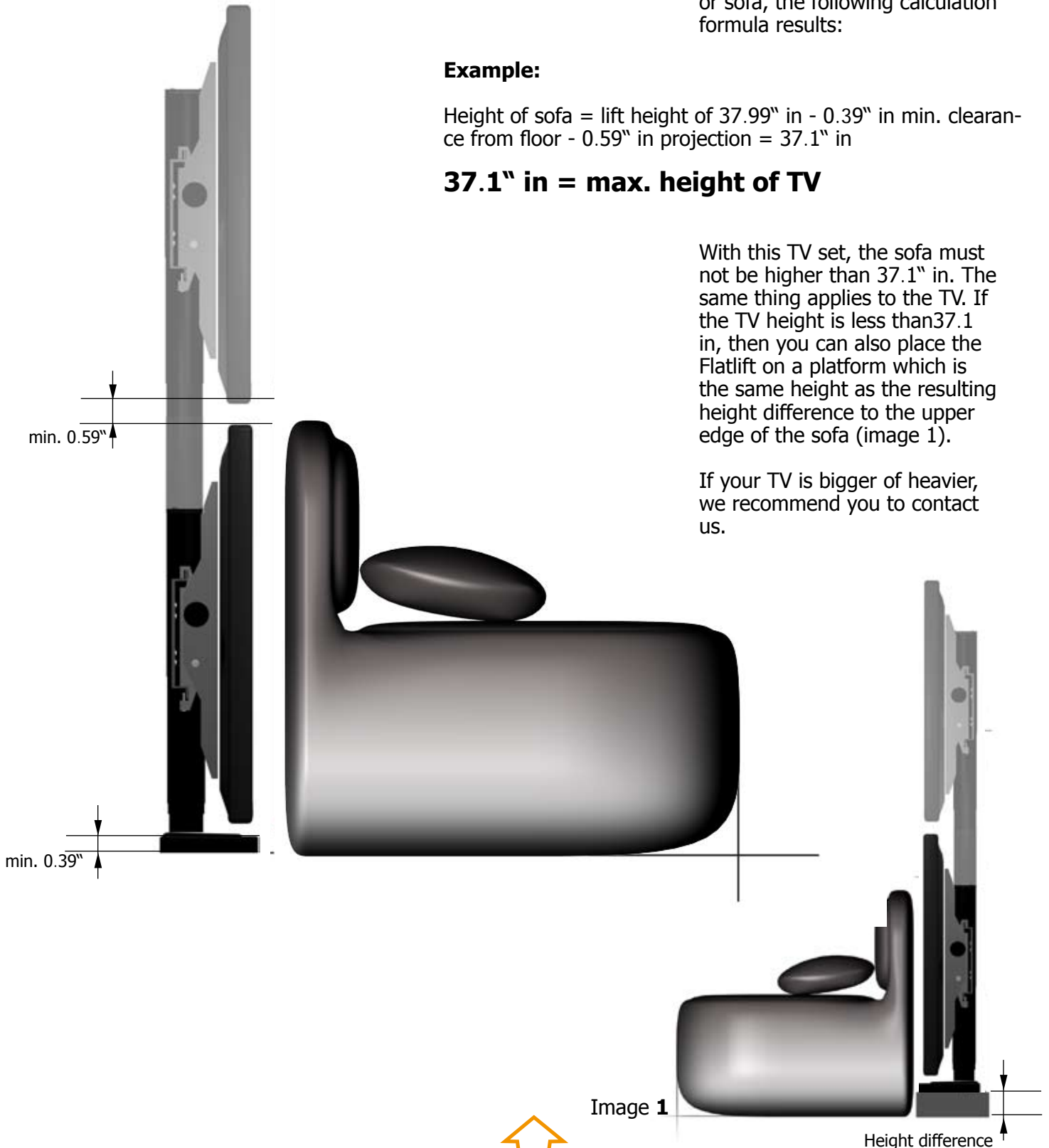

Outperform. Outlast.™

Trouble shooting:

If your Flatlift is not working properly, please make sure you check the following things:

The Flatlift won't move up or down

- ⇒ Is the power cord attached to the control box?
 - S Check the mains connection
- ⇒ Are all of the plugs properly connected to the control box? (NOTE: plugs which are not connected properly can damage the system)
 - S Check all of the connections
 - S The motor cables must be connected starting at port 1 and going up
- ⇒ Is there any evidence of damage to the cables, the control box, the remote control or the Flatlift?
 - S Damaged components must be exchanged. Please contact us.
- ⇒ The Flatlift has stopped and will only move in the wrong direction.
 - S Is your Flatlift fully extended already?
 - S Is the TV too heavy?
 - S Remote control command possibly deleted!
 - S Programming or initialisation error!
 - S Stopping point incorrectly programmed
- ⇒ Have you, in error, attached a TV to your Flatlift which is too heavy?
 - S Take the TV off the Flatlift and now see if the Flatlift works.
- ⇒ Is the remote control working?
 - S Change the battery in the remote control if necessary.
- ⇒ Is the receiver receiving the signals?
 - S When activating the remote control, the relay should 'click' on both channels. (If the receiver does not 'click', please delete the channels and reset them.
- ⇒ The lifting mechanism jerks or stutters?
 - S Please check as to whether another frequency source is also transmitting at 433 Mhz in your house (possible sources of problems: garage door opener, baby phone, alarm system or intercom). With a frequency jammer you will have to change over to a frequency of 868 Mhz! A free changeover from 433 Mhz to 868 Mhz is only possible within the first 7 days subsequent to the date of delivery.

Please contact us if this particular point is relevant to you.

If you experience any problems setting your system up or you experience an error, you can also contact us over the telephone or via Email:

Customer Service:

Via email: info@flatlift.net

Our telephone service time is 7.30 am - 5.30 pm. The telephone number is 1 800 571 0543. Please have the following information at hand / or include it in any email that you sent to us:

- ⇒ Your customer number
- ⇒ Your invoice number or delivery receipt number
- ⇒ The purchase date of your Flatlift
- ⇒ The name/model of your Flatlift system



Outperform. Outlast.™

FLATLIFT References



Legal Notice

Flatlift TV Lift Systems USA INC.
CEO: Sascha Rissel
848 Rainbow Blvd. #1573
NV 89107 Las Vegas / USA
Free Call: 800 571 0543
Fax: 702 944 4197
E-Mail: info@flatlift.net

Hours of business: Mon-Fri. 7:30 am- 5:30 pm
Status of document: JULY 2008

